



WeatherLink[®] Console

USER GUIDE

DAVIS 

Table of Contents

Introduction	... 03	Chapter 4: Navigating Your Console	... 08
WHAT'S IN THE BOX	... 03	YOUR DISPLAY SCREEN	... 08
Chapter 1: Get Ready	... 04	USING THE WEATHERLINK CONSOLE WITH MULTIPLE WEATHER STATIONS	... 09
SET UP YOUR WEATHER STATION SENSOR SUITE	... 04	CURRENT WEATHER HOME TAB	... 10
GATHER THE STATION IDS	... 04	GRAPH TAB	... 11
SIGN UP FOR WEATHERLINK.COM	... 04	DATA TAB	... 12
Chapter 2: Set Up Your WeatherLink Console	... 04	MAP TAB	... 12
POWER UP AND CONNECT TO WI-FI AND WEATHERLINK.COM	... 04	ACCOUNT TAB	... 13
CONFIGURE DEVICES	... 05	1. Account Information	... 13
DISPLAY FORMAT SETTINGS	... 06	2. Console Configuration	... 13
UNIT OF MEASUREMENT SETTINGS	... 06	3. Customize Display	... 13
GENERAL CONSOLE SETTINGS	... 06	• Console Settings	... 15
CONSOLE USE	... 06	• Alarms	... 16
Chapter 3: Mounting Your Console	... 07	• Device Information	... 16
CHOOSE THE CONSOLE LOCATION	... 07	• Terms and Conditions	... 16
MOUNTING YOUR CONSOLE ON A WALL	... 07	Chapter 5: Troubleshooting and FAQs	... 17
USING YOUR CONSOLE ON A TABLE, SHELF OR DESKTOP	... 07	CONTACTING DAVIS TECHNICAL SUPPORT	... 18
		Appendices	... 19
		APPENDIX A: WEATHER DATA	... 19
		APPENDIX B: SPECIFICATIONS	... 23
		APPENDIX C: WEATHER DATA SPECIFICATIONS	... 24
		APPENDIX D: WIRELESS REPEATER CONFIGURATION	... 26

Introduction

It's here!

Your next-gen WeatherLink Console will revolutionize the way you access, analyze, and understand the hyper-local weather data reported by your Vantage Pro2™ or Vantage Vue® sensor suite.

To get started, here are a few of the exciting features of this console.

- **Sophisticated & Stylish Color Touchscreen:** Easily navigate and customize your view right on the console Display screen.
- **Data Viewing:** Access all your sensor data – from temperature to wind to rain – both offline and logged into WeatherLink.com. Add an additional console to any room (within transmission range).
- **Custom Charting:** Visualize any of your sensor data in graph form.
- **Wi-Fi Connected:** Push your data to the WeatherLink Cloud to access your data on WeatherLink website. Use the WeatherLink app and join the largest global network of personal weather stations and share your data across the globe.
- **Data Collection:** See data from up to 8 transmitting stations – even 8 separate sensor suites.
- **Alarms:** Set hundreds of different alarms for multiple functions simultaneously.
- Stores years of historical data with settable local archive update rates. This console offers years of data and analysis even without internet connection. (Dependent upon update rate.)
- **Smart Home:** Connect your data to Alexa, Google Assistant, or other IoT/smart devices.

WHAT'S IN THE BOX

- WeatherLink Console
- Wall mount bracket
- Tabletop kickstand
- AC adapter and cable (no adapter with USB model)
- Hardware kit



CONSOLE

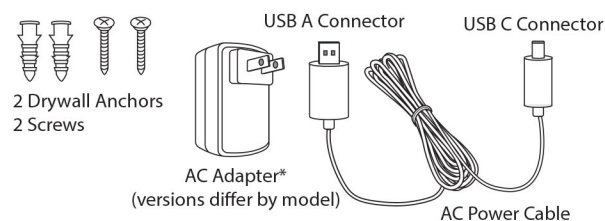

HARDWARE AND AC ADAPTER

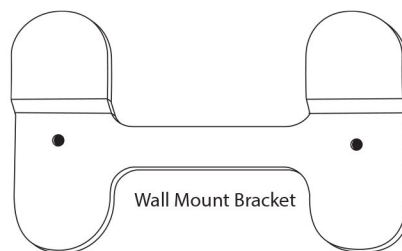

Wall Mount Bracket

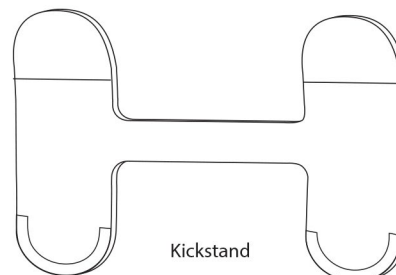

Kickstand

Chapter 1: Get Ready

1. SET UP YOUR WEATHER STATION SENSOR SUITE

If you have purchased your WeatherLink Console along with a new Vantage Pro2 or Vantage Vue sensor suite, you should set up your sensor suite first and have it up and running. Do this by following the instructions included with your sensor suite, but it might be easier if you wait to mount the sensor suite outside.

If you already have a Vantage Pro2 or Vantage Vue sensor suite up and running, you don't need to unmount it.

2. GATHER THE STATION IDS.

You will need to know what ID number your sensor suite is transmitting on. The default factory setting is ID1, but you may have changed this setting. If you have more than one transmitting station, each will be set to a different ID and you must know which station is transmitting on which ID.

Tip: If you have a Vantage Pro2 sensor suite, the ID is set by moving the DIP switches in the transmitter shelter of your sensor suite.

If you have a Vantage Vue sensor suite, the ID is set by pressing the transmitter ID button.

Refer to your sensor suite's manual if you need more information on confirming or changing your ID number.

3. SIGN UP FOR WEATHERLINK.COM.

A WeatherLink account is not required for this Console. It is a fully functional and powerful data display, storage, and analysis tool on its own. However, using it with a WeatherLink account will add considerable benefits including access to your data on your phone or computer, the option to store and access your archive data in safe cloud data archive, the ability to share your data with others, and the opportunity to be part of the WeatherLink global community of Davis weather stations. A basic account is free, but you can upgrade to Pro or Pro+ to enjoy added features.

Chapter 2: Set Up Your WeatherLink Console

POWER UP AND CONNECT TO WI-FI AND WEATHERLINK.COM

Note: You'll need your Wi-Fi Password.

Tip: Once your Console is set up and receiving data from the sensor suite, that data is permanent. To avoid recording erroneous data, take care not to tip the rain spoon during installation. You can also opt to power down the Console during mounting and maintenance. To power down, unplug the Console from AC power, then insert a paper clip into the "power" hole (the left most one, see image below) and hold until the power menu appears. Tap Power Off. Once the sensor suite is installed, power the Console back on by plugging it back into AC power.

1. Plug your Console into AC power using the AC adapter and power cable. The Console is AC-powered, with battery backup. The backup battery is meant to keep data logging when there is no AC power and will last less than a day.

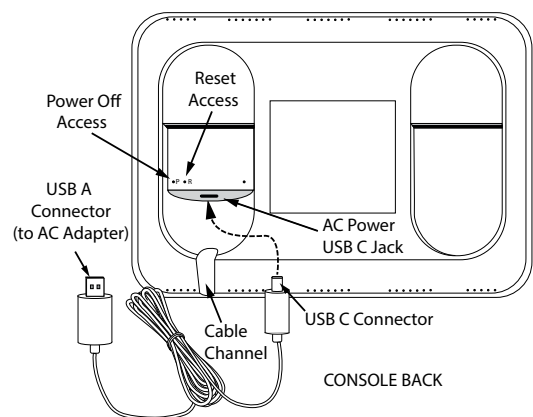

On the back of the Console, remove the plastic kickstand stand and any cardboard packaging.

Plug the USB A connector into the AC adapter and the USB C connector into the port on the back of the Console. Then plug the AC connector into AC power. Tuck the cable into the channel below the USB C jack.

Your console will automatically power up and your software will be automatically updated to the latest version. This can take up to 20 or 30 minutes.

Note: If after an extended period of time the console has not updated, you can reset it by pressing the “reset” hole (the center one) on the back of the console.

- The Console Installation screen will appear. Make sure you have a list of the transmitter IDs for your sensor suite and any other transmitting stations (such as a standalone Temperature/ Humidity Sensor installed on a Sensor Transmitter) ready. Tap **Begin Setup**.
- Follow the prompts to connect to your Wi-Fi.

Tip: If the device doesn't find your Wi-Fi network, make sure you have entered the correct password and that you are connecting to a 2.4 GHz network. It will not connect to a 5 GHz network. Then try repeating these steps.

Note: The console uses Wi-Fi to update the firmware upon first use, as well as to maintain very accurate time. You should connect to Wi-Fi even if you do not intend to upload your data to WeatherLink.com. After setup, the Console will not need to be connect to Wi-Fi, except to get automatic firmware updates which occur automatically at 3:00 a.m. local time when they are available. However, you can set it up without Wi-Fi. Choose Use Offline Mode and skip to step 6.

- Wait while the Console installs the latest updates. This may take as long as 30 minutes.
- The next screen will allow you to create or log into your WeatherLink account. Either create your account, log in to an existing account, or skip this section.
- Set your station's latitude and longitude. You can use the map to find your location if your console is connected to Wi-Fi, and latitude, longitude, and elevation will be set automatically.

Tip: Make sure the elevation is correctly set to the elevation of your Console, not your sensor suite. The barometer is housed in the Console and changes quickly with elevation. If your Console is in an upstairs room, be sure to add that elevation.

- Select country, time zone, time, and date (time should be automatically set if using in online mode) and choose to see time in either 24- or 12-hour format. Tap **Next**.
- Name your Console. Give you Console a short name, such as Bob's Home, or Aspen Cottage Weather. Tap **Next**.

CONFIGURE DEVICES

The next screens will let you set up the Console to “listen” to your transmitters.

- Click on the ID to which your sensor suite is set.
- In the next screen, choose the station type such as Vantage Vue or Vantage Pro2.
- Enter a name for this station such as My Vantage Vue, or Cellar Humidity Sensor.
- Make sure the Rain Collector setting matches your station's rain collector type (0.01 inches or 0.2 millimeters). Select any additional sensors you may have on your sensor suite or transmitter. For example, if you have a Vantage Pro2 Plus, choose Solar Rad and UV.
- Advanced settings:** This screen allows you to add a yearly rain value to date. (For example, if you are setting this device up in March, you can insert the rain data you may already have for January and February). If you have added a repeater, or a second wind station or third-party anemometer, configure those on this screen.

You can also calibrate temperature, humidity, or wind using this screen. If you are using a Vantage Pro2 and the anemometer arm cannot be installed pointing north, or if you are using a Vantage Vue and the solar panel cannot be installed so it points south, you will need to calibrate the wind direction on this screen. Please be aware that Davis sensors are quite accurate, and calibration is normally not needed. (See FAQs on calibration, page 15)

- Tap **Save**, then **Save** again to return to the Configure Devices Screen. Continue adding any transmitting stations you have in your system. Your Console can “listen” to up to 8 different transmitters.
- When you are finished, tap **Next**.

DISPLAY FORMAT SETTINGS

Make sure the display formats are as you want them to be. Tap **Next**.

UNIT OF MEASUREMENT SETTINGS

Make sure the unit measurements are as you want them to be. Tap **Next**.

GENERAL CONSOLE SETTINGS

1. On this screen, you can change your Local Archive Rate from the default of 5 minutes to 1 minute, 15 minutes, 30 minutes, or 60 minutes. You can change the Online Archive Rate in this screen as well.

Note: Understanding Data Rates

Your console will display current data as well as store it internally and optionally upload data to the WeatherLink Cloud for you to view on the WeatherLink app or website.

Current Conditions: Sensor suite data is transmitted every 2.5 seconds. See sensor update intervals, page 22.

Archive Data: Historical, or archive, data is stored both in the console, called “Local” archive data and, optionally, to the WeatherLink Cloud, called “Online” archive data.

“Local” Archive Rate refers to the frequency at which archive data is recorded on the Console’s internal database. The Console default archive rate is every 5 minutes. The more frequently data is added to the database, the faster the database will fill. However, the Console’s robust database will store historical data for years before it starts to overwrite the oldest data.

“Online” Archive Rate is the frequency at which the Console uploads data for online display and storage on WeatherLink.com. This archive rate depends on the type of WeatherLink plan you have selected. The default is set is 15 minutes. You can change it on the Console or on WeatherLink.com.

Tip: For Online Archive Rates more frequent than 15 minutes, you must be a Pro or Pro+ subscriber. You can upgrade to Pro or Pro+ on WeatherLink.com.

2. You can also set when you want your yearly rain season to start. For example, if your rainy season starts in April, you might want to start yearly accumulations on April 1 rather than January 1.
3. Choose whether you want your Console to track ambient lighting and automatically change the brightness depending on the light levels in the room. Or you can choose the brightness level yourself using the brightness slider.
4. Tap **Next**.

CONSOLE USE

On the next screens, select the primary use for your Console. Choose home or business. This information helps us design better hardware, software, and services. Tap **Next**.

Your installation is now complete! You should see data on your Display screen within 2 to 5 minutes.

Chapter 3: Mounting Your Console

CHOOSE THE CONSOLE LOCATION

You will want to place your WeatherLink Console in a location where it is accessible, and the Display screen is easy to read. It can either be mounted on a wall or used on a table, shelf, or desktop.

For the most accurate readings:

- Avoid placing the Console in direct sunlight. This may cause erroneous inside temperature and humidity readings and may damage the unit.
- Avoid placing the Console near radiators or heating/air conditioning vents.
- If you are mounting the Console on a wall, choose an interior wall. Avoid exterior walls that tend to heat up or cool down depending on the weather.
- Avoid placing your Console near large metallic appliances such as refrigerators, televisions, heaters, or air conditioners.

MOUNTING YOUR CONSOLE ON A WALL

1. Use the wall mount bracket included with your Console.
2. Use the holes to mark screw holes on the wall. Use a level to make sure the holes are level to each other.
3. Use a drill and a 7/64" (2.5 mm) drill bit to drill two pilot holes for the screws.
4. Use a hammer to carefully tap the drywall anchor into the hole until the collar of the drywall anchor is flush with the wall surface. Be careful to avoid driving the drywall anchor's collar beneath the surface of the wall.

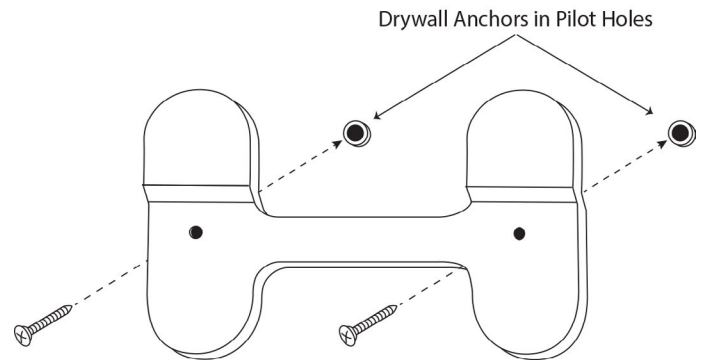

5. Place the bracket on the wall and use a Philips head screwdriver and the included screws to mount the bracket as shown.
6. Slide the Console down onto the bracket.

USING YOUR CONSOLE ON A TABLE, SHELF OR DESKTOP

Use the tabletop kickstand included. Insert kickstand into the back of the Console. There are "bumpers" on the legs to keep it from sliding.

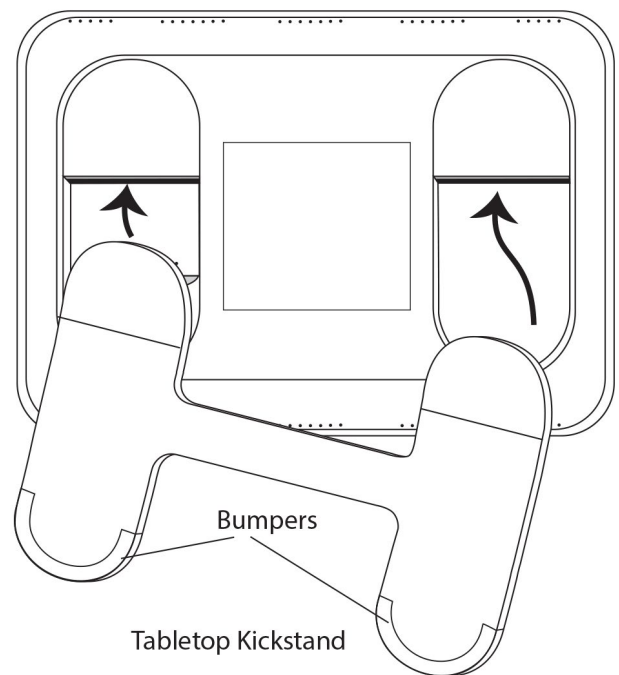

Chapter 4: Navigating Your Console

YOUR DISPLAY SCREEN

The customizable Display screen will let you see just what information you most want at a glance.

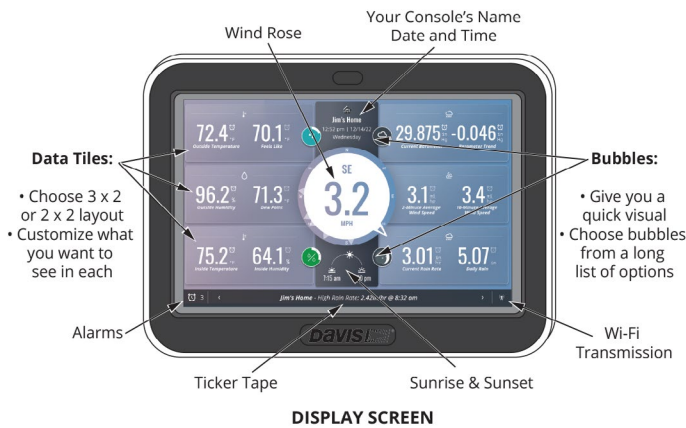

The Display screen is packed with all the current weather data you need as well as date and time, sunrise and sunset, alarms, and ticker tape. You will see real-time data as it arrives from the sensors. The ticker tape area offers informational messages about active alarms, low batteries on the sensor suite, resyncing with sensor suite and more. (And in a good rainstorm, look for the “raining cats and dogs” message!) You can also see how many alarms you have set; the number will appear next to the clock in the lower left corner of the Display screen.

The layout can be customized to show you the data you are most interested in. Choose a 3 X 2 layout for a total of 6 different tiles, plus the center wind rose. Within each tile, you can choose up to 2 different aspects. (For example, Outside Temperature and Outside Humidity in one tile.)

Or choose the 2 X 2 layout for 4 different tiles, plus the center wind rose, with two or just one aspect in each.



Tip: Want to make your Console easier to read from across the room? Choose the 2 X 2 layout with just one aspect in each tile. The displayed values will be bigger, making it easier to see from a distance. You can also choose High Contrast mode to make it even easier to see.



Note: All your data, whether you choose to display it or not on the Display is still updating. You can access it on the Data screen. You can change the Display at any time.

Note: To Customize your Display Screen, see **Customize Display Menu Item** on page 11.

USING THE WEATHERLINK CONSOLE WITH MULTIPLE WEATHER STATIONS

If you have more than one station on your WeatherLink account, you can choose to see current conditions data from either one on the Display Screen. The primary station's data is the default. To see additional or "remote" stations, swipe left. Swipe right to return to the primary station. Note that data from your primary station is always used in the other tabs (data, charts, and map).

For example, you might have a Vantage Pro2 Plus reporting data from your backyard, and a Vantage Vue installed at your mountain cabin. Your Display will show data from your primary station, the Vantage Pro2 Plus. Swipe to the left anywhere on the bulletin and the data in the tiles will be replaced by data from your cabin Vantage Vue.

Tip: Data from additional or remote stations replaces the data in the tiles on the bulletin as it is set up for the primary station. When setting up your tiles on the display, consider that any data that your remote station does not report will show "NA."

If you choose data parameters that both the primary and remote stations report, all tiles will show data. For example, if you set up a tile to show UV and Solar Radiation data from your Vantage Pro2 Plus, when you swipe to see the cabin Vantage Vue, the UV and Solar Radiation tile will show "NA."

CURRENT WEATHER HOME TAB

Tap the **House** symbol area at the top of the display screen to access the various tab sections.



This will take you to the first tab: the Current Weather Home screen.

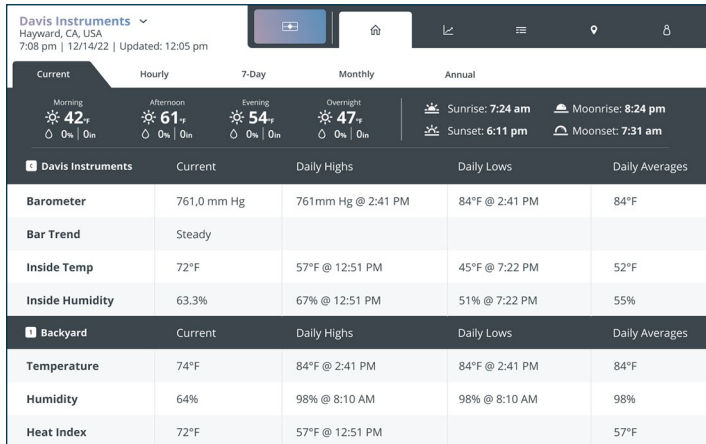

This screen gives you all the details of your current weather including sunrise and sunset, and daily highs, lows and averages, and today's forecast. Scroll down to see current data from all your sensors.

If you are online (that is, logged into WeatherLink.com), you'll also get hourly, 7-day, Monthly, and Annual forecast history and forecasts.

- Tap the "Hourly" tab to see hour by hour historical data back 24 hours, and forecasts forward hour by hour for 24 hours. Scroll right and left more data.

- In the lower right corner, tap the "Jump to Current" button to move the "now" divider to center of the chart.

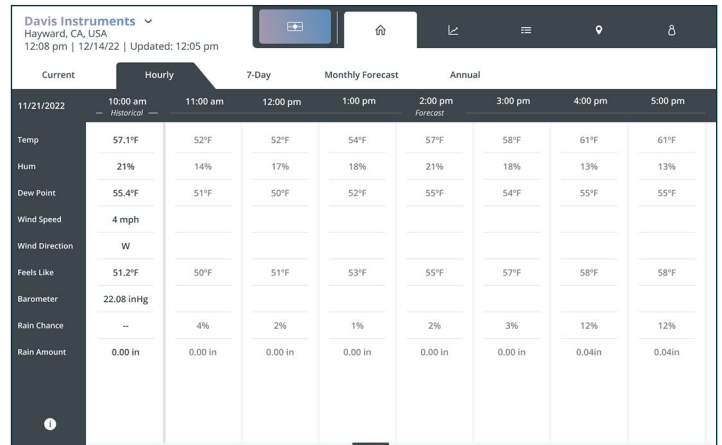

- Tap the "7-day" tab to see data graphs for 7 days with actual historical data for past days and forecasts for future days. Use the < and > arrows on the top of the chart to move the start of the week backward or forward. Days in the past will show your historical data, while days in the future will show forecasts.



- Tap the “Monthly” tab to see weather data recaps for every day of the month. At the top of the page, you’ll see the average high and low temperature, as well as rainfall and any records set this month to date. On the calendar, you’ll see the actual high and low temperatures and rainfall amount for past days and today as of now. You will also see a quick visual representation of the amount of rain. Rainfall is indicated by bars: One bar indicates rainfall from 0.01 to 0.09 inches; 2 bars indicate rainfall from 0.1 to 0.9 inches; 3 bars indicate more than one inch. Future days will show forecasted high and low temperatures, forecasted humidity and rainfall, and forecast icon. Use the < and > arrows to scroll to months in the past or future.

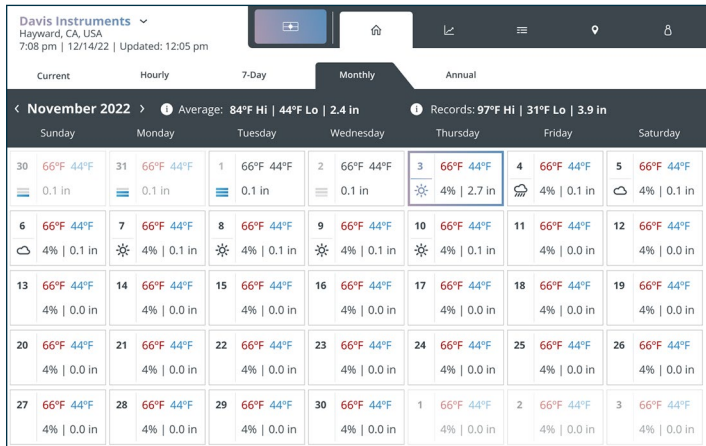

- Tap the “Annual” tab to see climatological information for your area. Scroll down to see temperature and rainfall charted for both the climatological average and your station’s data.

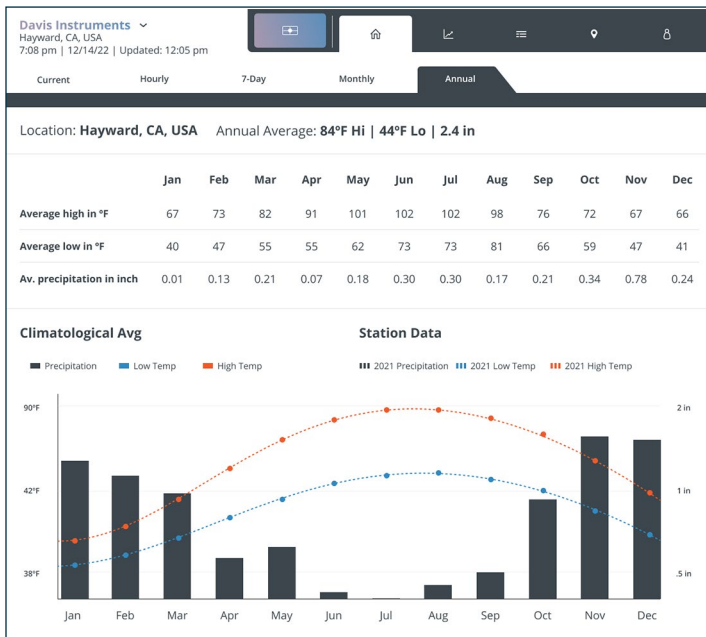

GRAPH TAB



Tap the graph symbol to open the Graph screen.



On this page, you can graph your weather data over a period you select. You can touch the graph line to get pinpointed data for each graphed point.

1. To choose one or two parameters you want to graph, tap the Data symbol: Choose the parameters you want to graph, such as High Temperature, Low Temperature or Dew Point.
2. To choose the date and span you want to graph, click the Calendar and time range symbols: You can choose 1 hour to 1 year starting at any date/time. Check “Automatically show last set amount of time” to start backward from now. If you uncheck the box, you can select a start time and date. The graph will show data from this start time forward over the span you choose. For example, choosing to start on November 21, this year, for 3 days, starting at 2 p.m., will show a graph of data from November 21 at 2 p.m. to November 24 at 2 p.m.
3. Tap **Save**.

DATA TAB

Tap the data symbol  to open the Data screen.

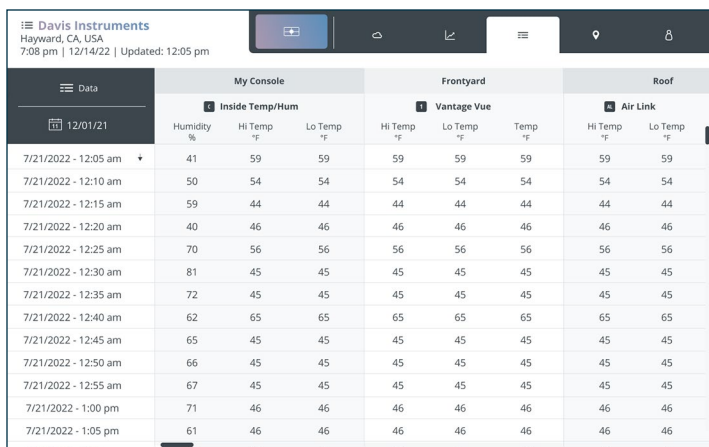

Date/Time	My Console			Frontyard			Roof	
	Humidity %	Hi Temp °F	Lo Temp °F	Hi Temp °F	Lo Temp °F	Temp °F	Hi Temp °F	Lo Temp °F
7/21/2022 - 12:05 am	41	59	59	59	59	59	59	59
7/21/2022 - 12:10 am	50	54	54	54	54	54	54	54
7/21/2022 - 12:15 am	59	44	44	44	44	44	44	44
7/21/2022 - 12:20 am	40	46	46	46	46	46	46	46
7/21/2022 - 12:25 am	70	56	56	56	56	56	56	56
7/21/2022 - 12:30 am	81	45	45	45	45	45	45	45
7/21/2022 - 12:35 am	72	45	45	45	45	45	45	45
7/21/2022 - 12:40 am	62	65	65	65	65	65	65	65
7/21/2022 - 12:45 am	65	45	45	45	45	45	45	45
7/21/2022 - 12:50 am	66	45	45	45	45	45	45	45
7/21/2022 - 12:55 am	67	45	45	45	45	45	45	45
7/21/2022 - 1:00 pm	71	46	46	46	46	46	46	46
7/21/2022 - 1:05 pm	61	46	46	46	46	46	46	46

This screen shows your archive, or historical, data over any selected day. You can choose which data to see by tapping the data symbol:  in the upper left corner, and the day and start time by clicking the calendar symbol below it.

Scroll down and side to side to see all the data in your Console's database for that day.

MAP TAB

The Map Tab lets you see conditions and details for stations worldwide on your screen.

The map displays data from all the Davis weather stations of users who have made their station's current outside data "public." Participating stations appear on the map by location as colored dots that represent either the temperature range (default) or air quality. Just a glimpse shows you either the prevailing temperature or air quality and makes trends easy to see. There is a color key bar at the bottom of the map display.

Note: Being part of the WeatherLink community by sharing your current outside weather and air quality data provides a great service to both weather enthusiasts and the general public. Inside data is never shown publicly. We encourage you to set your station to Public on WeatherLink.com.

Click the Map Tab  icon to open the map with your station generally centered in the display. You can zoom in or out by clicking the + or -, or by using two fingers to zoom in/out or move the map. Double tapping on the map also zooms in.

Tip: You can recenter your station on the map by clicking the Center icon  next to the search bar.

Tap your station to see your current outside temperature and humidity, wind speed, barometric pressure and trend, and daily rain total on the right-hand side of the screen. Tap anywhere on the map to close the data display.

You can view the current data from other Davis stations by tapping on any colored dot on the map. You can also see data from a specific station. In the Search Station field on the upper left of the map, enter either the name of a station (such as "John's Backyard") or the location (such as "Paris, France"). Choose Station (default) or Location. Choose the station or location you want to view from the list. The station's name and its data will appear on the right-hand side of the map.

Overlay Temperature or Air Quality:

If you or another station owner also has a Davis AirLink air quality monitor, its data can be viewed on the map. By default, the map uses a temperature overlay where the color of the dot representing a station indicates the outside temperature range.

To switch to an air quality overlay, tap the layers icon on the upper right corner of the map and choose air quality and the air quality standard you prefer. Tap Save Changes and Exit to return to the map. Now when you tap a station location, you will see air quality data below the weather data (if the station also has a weather station) on the right of the map.

Tip: The wood smoke adjustment should be selected when active wood fires are affecting the AQI.

Whether you have the temperature or air quality overlay, there is a color key bar at the bottom of the map display.

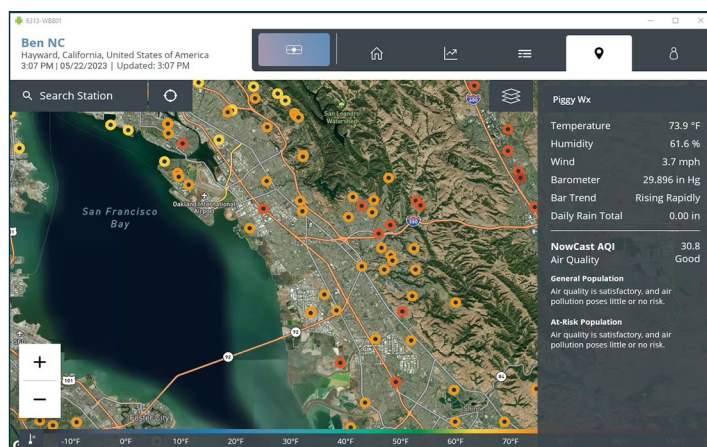

ACCOUNT TAB

Tap the Account symbol  to open the Account screen.

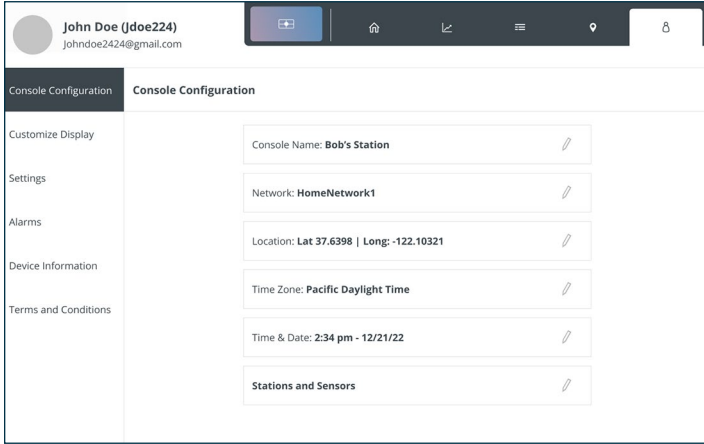

At the top left, you will see your name, your username, and your email address.

Note: The account screen allows you to edit or add account information, customize your Display, change console settings, set alarms, and manage your device.

Note: If you are using your Console without uploading to WeatherLink.com, "offline" mode, the menu will differ.

Account Tab Menu items

1. Account Information

Tap this option to edit your account information such as your name, address, or email address. Your WeatherLink subscription status and when your subscription is due for renewal are also shown. Tap the pencil to edit the field.

2. Console Configuration

Tap this option to see your Console's name, Wi-Fi network, location, and time zone. To edit, tap the pencil.

3. Customize Display

To customize your Display, tap the Customize Display menu item.

1. Choose the layout. Choose a 3 X 2 layout for a total of 6 different tiles, plus the center wind rose. Within each tile, you can choose up to 2 different data points. (For example, Outside Temperature and Outside Humidity in one tile.)

Or choose the 2 X 2 layout for 4 different tiles, plus the center wind rose, with two or just one aspect in each.

2. You can choose to turn High Contrast Mode on for easiest viewing.



3. Tap the **Customize Display** button on upper right to save your layout choice and proceed to the tile and bubble options page.

Display Tips: Want to make your Console easier to read from across the room? Choose the 2 X 2 layout with just one data point in each tile. The displayed values will be bigger, making it easier to see from a distance. Turn High Contrast on for even easier viewing.

Keep data points with the longest values displayed, like barometer in the corners where the most space is available. You might notice that the center wind rose encroaches a bit on the two center row tiles.



4. Choose the data points you want to see in each tile.

Starting with the upper left tile, choose the parameter you want to see: Temperature/Humidity, Wind, Barometer, Rain, Solar/UV, Leaf Wetness and Soil Temperature, or Current Daily Forecast. Tap Edit to see your options for each parameter in either a Visual Preview or List view.

For example, if you choose to have Temperature/Humidity in the upper left tile, on this page you can choose whether you want Outside and Inside Temperature in the tile, or Outside Temperature and Dew Point, or just Outside Temperature.

5. Make sure the correct sensor is selected. (For example, outside temperature from your sensor suite; inside temperature from your Console.)
6. Click **Save**.
7. Continue to choose options for all the tiles. You can see a preview of your selection at any time by tapping the Live Preview button in the upper right side of the Customize Display page.
8. Customize the four “Weather Bubbles” as well. Scroll down to choose each bubble location, then tap Edit to choose a parameter for that bubble. You will see the various graphical images that will be displayed as the data changes over the day.

Choose a weather parameter:

- Temperature
- Humidity
- Heat Index
- Wind Chill
- Barometric Trend
- UV
- Sky Condition/Forecast
- Moon Phase

9. Tap **Next**. Make sure the correct sensor for this data is selected, then tap **Save**.

Console Settings

This menu item lets you fine tune your Console.

There are four tabs at the top of this screen.

1. Display Settings Tab allows you set preferences for Sleep, Do Not Disturb, Brightness, Ambient Light Tracking and Energy Saver Mode.

Enabling Sleep will turn the display off after a period of time when the console is unplugged or when the Energy Saver Mode is enabled. It will “wake up” if you tap the screen once, or if an alarm is activated.

The Do Not Disturb feature allows you to set times when alarms do not sound or wake the screen up (or you, for that matter). To enable the Do Not Disturb feature, tap the pencil icon in the Do Not Disturb field. Choose the times during which you do not want the console to wake up when an alarm is triggered. (The default setting is 12 A.M. to 7 A.M.) Tap Save Changes and Exit.

Tip: You can always “wake up” your console by tapping once on the screen.

Brightness lets you set your preferred brightness.

Ambient Light Tracking allows the screen to dim or brighten as the room darkens or lightens.

Energy Saving Mode allows your display to go to sleep when not in use and there is no ambient light. If Energy Saving is not enabled (default setting), the backlight does not turn off; the display sleeps only when the console is unplugged and on battery backup. To turn on Energy Saving Mode, tap the On button.

2. The Units of Measure Tab allows you to customize the units of measurement you prefer.

- **Temperature:** Fahrenheit or Celsius
- **Soil Moisture:** Kpa, bar, or cb
- **Wind:** miles per hour, knots, kilometers per hour, or meters per second
- **Rain & ET:** inches or millimeters
- **Elevation:** Feet or meters
- **Barometer:** inHg, mmHg, mb, hPa

3. Display Format Tab allows you to choose how you want to see information on your Display Screen.

- Language
- Date Format
- Time Format
- Number Format
- Display Resolution
- Alarms

4. Console Settings Tab allows you change display formats to more precision, calibrating, or to change what you set up previously.

- Calibrate Inside Temperature and Humidity or Barometer.

Note: Davis Instruments sensors are quite accurate and should not need calibrating. However, you may do so on this screen.

- Set Local Archive Rate

This is the rate at which archive data is stored in the Console’s database. (It is NOT the frequency at which current data is updated, nor is it the frequency at which archive data is stored on WeatherLink.com.)

You can select 1 minute, 5 minutes (default setting), 15 minutes, 30 minutes, or 60 minutes. Remember that less frequent rates mean more data can be stored and therefore it will take longer before the database is filled and older data is overwritten.

Tip: To better understand Local Archive Rate, see Note: **Understanding Data Rates on page 6.**

- Edit elevation. Elevation is important for accurate barometric pressure readings. The Elevation should be as close as possible to the elevation of the Console itself, which houses the barometer. Take into account such things as the Console being in an upstairs room.
- Edit yearly rain year start.
- Set Online Archive Rate. This is the frequency at which your historical data is uploaded to the WeatherLink Cloud. Some faster update rates can only be selected if you have a Pro or Pro+ subscription.
- Control the Console’s brightness
- Choose Ambient Light Tracking to allow the consoles to change brightness according to the available light in the room.

Alarms

This menu item allows you to set any number of alarms for any parameter. For example, you can set an alarm to notify you when the outside temperature nears freezing, or inside humidity reaches your selected threshold. When the condition for which you set an alarm occurs, the Console will notify you by listing the condition in the ticker tape area of the Display (when your Console is showing the Display screen) and with an audible alarm if you choose. You can choose the sound and the volume of the audible alarm.

Tip: The volume and sound can be set for each alarm individually. This means you can have one sound that indicates that your rain alarm has been activated and another that indicates your temperature alarm has been activated.

There are two tabs on this screen:

Use the **Set Alarm** tab to set up your alarms.

1. To set an alarm, enter a threshold value in the parameter you choose. For example, in the Outside Temperature fields, enter 33°F in the "Lo" field.

2. Click the Alarm Sound symbol to select an alarm sound and volume and to preview the sound.



3. Click Save to save your alarm.

4. To turn off the alarm, click the Off Alarm symbol that will appear on the Display screen. It will go off itself otherwise after one minute.



Use the **Alarm History** tab to see a list of alarms that have occurred and when.

Remote Alarms

If you have more than one station, you can set alarms on WeatherLink.com for any of your stations and send them to your console. (On your WeatherLink.com page, click the "wrench" icon, then Notifications, Console Notifications.)

Device Information

This menu item lets you see information about your Console and transmitters. At the top of the screen, you'll see the console's firmware, operating system, and radio module.

Note: Console and operating system are both updated automatically at 3:00 a.m. local time when they become available.

You'll also see diagnostic information about your Console and sensor suite, including:

Console:

- Strength of Wi-Fi signal
- Whether the Console is connected to Wi-Fi
- Battery charge

Sensor Suite (or other transmitting station):

- Radio signal strength
- Whether it is connected to the Console
- Sensor suite battery state

Click the > arrow next to your sensor suite for further diagnostic information.

You can also choose **Factory Reset** on this screen. Use this to reset your Console to factory settings. **Note that all data in your Console will be lost if you reset your Console.**

Terms and Conditions

Please read the Davis Instruments Privacy Policy.

To return to the Display screen at any time, tap the Display symbol.



Chapter 5: Troubleshooting and FAQs

My weather readings seem wrong. How can I calibrate my console?

Davis sensors are factory-calibrated for accuracy and will normally not need any calibration. Comparing your data to TV reports or other sources is not recommended because weather data varies by microclimate. However, if you believe your Console does need calibration, go to the Accounts tab, then tap Console Configuration, then tap Stations and Sensors. Scroll down to the ID number of your station and tap Edit. On the sensor detail page, tap Advanced Settings. On the next screen, you may enter calibrations for outside temperature and humidity, and wind. To calibrate inside temperature and humidity, in the Accounts tab, tap Console Settings.

Vantage Pro2 and Vantage Vue sensor suites are factory-set to record wind direction accurately when installed so that the anemometer arm on the Vantage Pro2 points north, or the solar panel on the Vantage Vue points south. If your installation is in the Southern Hemisphere, or for some reason you cannot install the anemometer or sensor suite so the orientation is correct, you must calibrate wind direction on the Console.

Vantage Pro2: In the Wind Direction field, enter the direction, in degrees, the anemometer arm actually points.

Vantage Vue: In the Wind Direction field, enter the direction, in degrees, the solar panel actually points.

Why didn't I hear the audible alarm when an alarm was triggered?

The main Display screen must be open to hear the audible alarm.

On the diagnostics page, my radio signal strength shows "fair." Is that okay?

Yes. The signal strength is a real-time reading and can fluctuate. Fair and good are both indicators of sufficient strength. You can verify by looking at the reception percentage.

How do I turn off an alarm?

When an alarm is activated, you will see a notification in the Ticker Tape area of the Display screen. To silence the audible alarm, tap the Alarm Off symbol. The alarm will go off by itself after a minute if you do not turn it off.

Can I clear some data like erroneous rain tips?

No. Erroneous data will be permanently recorded. You can avoid recording erroneous data by being careful not to tip the rain spoon or by powering down your Console when mounting, moving, or maintaining your sensor suite. See page 4 for instructions on how to power down your console.

How long will the backup battery last if I lose AC power?

Less than a day.

Why can't I see forecasts?

Internet-based, localized forecasts are only available when you are in Online mode. (Logged in to WeatherLink.com.)

Can I power my console from a USB port on my computer?

No. The computer USB port will not supply sufficient power. Use the included 2A AC adapter.

Do I need to connect to Wi-Fi?

No, the console will run as a standalone device. However, Wi-Fi is needed for keeping accurate time on the console and for firmware updates. (You do NOT need to be logged in to WeatherLink.com; you just need to be connected to Wi-Fi.)

I am not sure about whether to upload to WeatherLink.com. Can I set this up later?

Yes, you can create a WeatherLink.com account any time now or in the future. However, the start date for your data on WeatherLink.com will be when you create and connect your Console to your account.

If I disconnect from WeatherLink.com account and reconnect later, will the data stored in the Console be pushed to WeatherLink.com?

Yes. When reconnected, your Console's stored data will be pushed to your WeatherLink.com account.

What does "Offline" and "Online" mode mean?

Offline mode keeps you connected to Wi-Fi to ensure accurate time but disconnected from WeatherLink.com.

Online means your Console is connected to Wi-Fi and also connected to your account on WeatherLink.com. This will give you access to live updates on your mobile app and your page on WeatherLink.com, as well as specialized internet-based forecasts.

Your Console can also operate offline and off Wi-Fi as a standalone device.

How can I change my Wi-Fi network?

Go to the Account tab and tap Console Configuration. Tap the pencil icon next to your network.

Can I retransmit from an older Vantage Pro2 or Vantage Vue console?

Yes. Your older console is a useful transmitter that can retransmit to your new one. Refer to the original Vantage Pro2 or Vantage Vue Console User Guides to learn how to set up your old console to retransmit on its own ID number. Choose any open ID.

You will need to set your WeatherLink Console to listen to this transmitter ID. The old console will become one of your "Stations and Sensors." To add it, go to the Accounts screen, choose Console Configuration, then choose Stations and Sensors. Tap the ID number that the old console is retransmitting on. On the next screen, choose Vantage Pro2 or Vantage Vue depending on your sensor suite.

CONTACTING DAVIS TECHNICAL SUPPORT

For questions about installing or operating your WeatherLink Console, please contact Davis Technical Support. We'll be glad to help.

Online: www.davisinstruments.com See user manuals, product specifications, application notes, software updates, and more.

E-mail: support@davisinstruments.com

If needed, you can also call our support team at **510 732-7814**, Mon. - Fri. 7:00 a.m. to 5:30 p.m., Pacific time.

Appendices

APPENDIX A: WEATHER DATA

Refer to this appendix to learn more about the weather variables that are measured, displayed, and logged by your Console. Some weather variables require optional sensors.

Wind

The anemometer measures wind speed and direction. The Console calculates a 10-minute average wind speed and 10-minute dominant wind direction. The 10-minute average wind speed is displayed in the Console ticker whenever wind has been selected on the Console. The last six 10-minute dominant wind directions are included in the compass rose wind display.

Temperature

The sensor suite houses the outside temperature sensor in a vented and shielded enclosure that minimizes the solar radiation induced temperature error. The Console houses the inside temperature sensor. Additional temperature sensors are available for wireless stations and can measure up to eight locations.

Apparent Temperatures

Your Console calculates three apparent temperature readings: Wind Chill, Heat Index, and the Temperature/Humidity/Sun/Wind (THSW) Index. Apparent temperatures use additional weather data to calculate what a human body perceives the temperature to be in those conditions.

Wind chill

Wind chill takes into account how the speed of the wind affects our perception of the air temperature. Our bodies warm the surrounding air molecules by transferring heat from the skin. If there's no air movement, this insulating layer of warm air molecules stays next to the body and offers some protection from cooler air molecules. However, wind sweeps that warm air surrounding the body away. The faster the wind blows, the faster heat is carried away and the colder you feel. Wind has a warming effect at higher temperatures.

Note: Wind chill is not calculated above 92° F (33° C).

Heat Index

The Heat Index uses temperature and the relative humidity to determine how hot the air actually “feels.” When humidity is low, the apparent temperature will be lower than the air temperature since perspiration evaporates rapidly to cool the body. However, when humidity is high (i.e., the air is more saturated with water vapor) the apparent temperature “feels” higher than the actual air temperature, because perspiration evaporates more slowly.

Temperature/Humidity/Sun/Wind (THSW) Index

The THSW Index uses humidity and temperature like for the Heat Index, but also includes the heating effects of sunshine and the cooling effects of wind (like wind chill) to calculate an apparent temperature of what it “feels” like out in the sun. The THSW Index requires a solar radiation sensor.

Humidity

Humidity itself simply refers to the amount of water vapor in the air. However, the total amount of water vapor that the air can contain varies with air temperature and pressure. Relative humidity takes into account these factors and offers a humidity reading which reflects the amount of water vapor in the air as a percentage of the amount the air is capable of holding. Relative humidity, therefore, is not actually a measure of the amount of water vapor in the air, but a ratio of the air's water vapor content to its capacity. When we use the term humidity in the manual and on the screen, we mean relative humidity.

It is important to realize that relative humidity changes with temperature, pressure, and water vapor content. A parcel of air with a capacity for 10 g of water vapor which contains 4 g of water vapor, the relative humidity would be 40%. Adding 2 g more water vapor (for a total of 6 g) would change the humidity to 60%. If that same parcel of air is then warmed so that it has a capacity for 20 g of water vapor, the relative humidity drops to 30% even though water vapor content does not change.

Relative humidity is a crucial factor in determining the amount of evaporation from plants and wet surfaces since warm air with low humidity has a large capacity to absorb extra water vapor.

Dew Point

Dew point is the temperature to which air must be cooled for saturation (100% relative humidity) to occur, providing there is no change in water vapor content. The dew point is an important measurement used to predict the formation of dew, frost, and fog. If dew point and temperature are close together in the late afternoon when the air begins to turn colder, fog is likely during the night. Dew point is also a good indicator of the air's actual water vapor content, unlike relative humidity, which takes the air's temperature into account. High dew point indicates high water vapor content; low dew point indicates low water vapor content. In addition, a high dew point indicates a better chance of rain, severe thunderstorms, and tornadoes.

You can also use dew point to predict the minimum overnight temperature. Provided no new fronts are expected overnight and the afternoon relative humidity is greater than or equal to 50%, the afternoon's dew point gives you an idea of what minimum temperature to expect overnight, since the air can never get colder than the dew point. Dew point is equal to air temperature when humidity = 100%.

Rain

Your Vantage Pro2 or Vantage Vue sensor suite uses a tipping spoon rain collector that measures 0.01" or 0.2mm for each tip of the spoon. Your Console logs rain data in the same units it is measured in and converts the logged totals into the selected display units (inches or millimeters) at the time it is displayed.

Four separate variables track rain totals: "rain storm," "daily rain," "monthly rain," and "yearly rain." Rain rate calculations are based on the interval of time between each bucket tip, which is each 0.01" rainfall increment or 0.2 mm.

Barometric Pressure

The weight of the air that makes up our atmosphere exerts pressure on the surface of the earth. This pressure is known as atmospheric pressure. Generally, the more air above an area, the higher the atmospheric pressure, this means that atmospheric pressure changes with altitude. For example, atmospheric pressure is greater at sea level than on a mountaintop. To compensate for this difference and facilitate comparison between locations with different

altitudes, atmospheric pressure is generally adjusted to the equivalent sea level pressure. This adjusted pressure is known as barometric pressure. The Console measures atmospheric pressure. When you enter your location's altitude, the Console stores the necessary offset value to consistently translate atmospheric pressure into barometric pressure.

Barometric pressure also changes with local weather conditions, making barometric pressure an extremely important and useful weather forecasting tool. High-pressure zones are generally associated with fair weather while low-pressure zones are linked with poor weather. For forecasting purposes, however, the absolute barometric pressure value is generally less important than the change in barometric pressure. In general, rising pressure indicates improving weather conditions while falling pressure indicates deteriorating weather conditions.

Solar Radiation

What we call "current solar radiation" is technically known as Global Solar Radiation, a measure of the intensity of the sun's radiation reaching a horizontal surface. This irradiance includes both the direct component from the sun and the reflected component from the rest of the sky. The solar radiation reading gives a measure of the amount of solar radiation hitting the solar radiation sensor at any given time, expressed in Watts/sq. meter (W/m²). Solar radiation requires the solar radiation sensor.

UV (Ultraviolet) Radiation

Energy from the sun reaches the earth as visible, infrared, and ultraviolet (UV) rays. Exposure to UV rays can cause numerous health problems, such as sunburn, skin cancer, skin aging, cataracts, and can suppress the immune system. The Vantage Pro2 helps analyze the changing levels of UV radiation and can advise of situations where exposure is particularly unacceptable. UV radiation requires the UV radiation sensor. The Console displays UV readings in two scales: MEDs and UV Index.

Note: Your station's UV readings do not take into account UV reflected off snow, sand, or water, which can significantly increase your exposure. Nor do your UV readings take into account the dangers of prolonged UV exposure. The readings do not suggest that any amount of exposure is safe or healthful. Do not use your Console to determine the amount of UV radiation to which you expose yourself. Scientific evidence suggests that UV exposure should be avoided and that even low UV doses can be harmful.

TABLE A-2: ENVIRONMENT CANADA SKIN TYPES AND REACTION TO THE SUN^A

Skin Type	Skin Color	History of Tanning & Sunburning
I	White	Always burns easily, never tans
II	White	Always burns easily, tans minimally
III	Light Brown	Burns moderately, tans gradually
IV	Moderate Brown	Burns minimally, tans well
V	Dark Brown	Burns rarely, tans profusely
VI	Black	Never burns, deep pigmentation

a. Developed by T. B. Fitzpatrick of the Harvard Medical School. More about the Fitzpatrick Skin Types is available in: Fitzpatrick TB. Editorial: the validity and practicality of sun-reactive skin types I through VI. Arch Dermatol 1988; 124:869-871

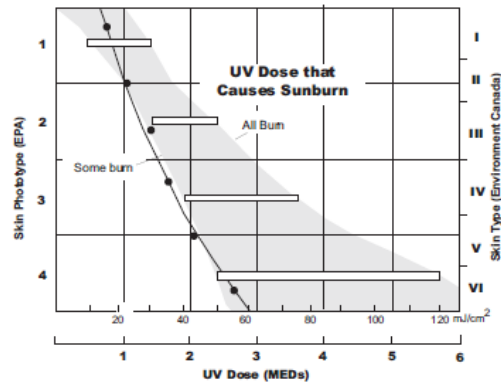

UV Dose and Sunburn - Use this plot to estimate the MED dose leading to sunburn. A person with Type II (Environment Canada) skin type might choose 0.75 MED as the maximum for the day; in contrast, a person with Type V (Environment Canada) Skin Type might consider 2.5 MEDs a reasonable dose for the day. NOTE: the Vantage Pro2 assumes a Fitzpatrick (Environment Canada) Skin Type of II.

UV MEDs

MED (Minimum Erythemal Dose) is defined as the amount of sunlight exposure necessary to induce a barely perceptible redness of the skin within 24 hours after sun exposure. In other words, exposure to 1 MED will result in a reddening of the skin. Because different skin types burn at different rates, 1 MED for persons with very dark skin is different from 1 MED for persons with very light skin.

Both the U.S. Environmental Protection Agency (EPA) and Environment Canada have developed skin type categories correlating characteristics of skin with rates of sunburn.

TABLE A-1: EPA SKIN PHOTOTYPES

Skin Phototype	Skin Color	Tanning & Sunburn history
1 - Never tans, always burns	Pale or milky white; alabaster	Develops red sunburn; painful swelling, skin peels
2 - Sometimes tans, usually burns	Very light brown; sometimes freckles	Usually burns, pinkish or red coloring appears; can gradually develop light brown tan
3 - Usually tans, sometimes burns	Light tan; brown, or olive; distinctly pigmented	Rarely burns; shows moderately rapid tanning response
4 - Always tans; rarely burns	Brown, dark brown, or black	Rarely burns; shows very rapid tanning response

UV Index

The Console can also display UV Index, an intensity measurement first defined by Environment Canada and since been adopted by the World Meteorological Organization. UV Index assigns a number between 0 and 16 to the current UV intensity. The US EPA categorizes the Index values as shown in table A-3. The lower the number, the lower the danger of sunburn. The Index value published by the U.S. National Weather Service is a forecast of the next day's noontime UV intensity. The index values displayed are real-time measurements.

TABLE A-3: UV INDEX

Index Values	Exposure Category
0 - 2	Low
3 - 5	Moderate
6 - 7	High
8 - 10	Very High
11+	Extreme

Evapotranspiration (ET)

Evapotranspiration (ET) is a measurement of the amount of water vapor returned to the air in a given area. It combines the amount of water vapor returned through evaporation (from wet surfaces) with the amount of water vapor returned through transpiration (exhaling of moisture through plant stomata) to arrive at a total. Effectively, ET is the opposite of rainfall, and it is expressed in the same units of measure (inches, millimeters).

The Console uses air temperature, relative humidity, average wind speed, and solar radiation data to estimate ET, which is calculated once an hour on the hour. ET requires the optional solar radiation sensor.

Leaf Wetness

Leaf wetness provides an indication of whether the surface of foliage in the area is wet or dry by indicating how wet the surface of the sensor is. The leaf wetness reading ranges from 0 (dry) to 15. Leaf wetness requires an optional Leaf & Soil Moisture/Temperature Station and is only available for Wireless Vantage Pro2 Stations.

Soil Moisture

Soil Moisture, as the name suggests, is a measure of the moisture content of the soil. Soil moisture is measured on a scale of 0 to 200 centibars and can help choose times to water crops. The soil moisture sensor measures the vacuum created in the soil by the lack of moisture. A high soil moisture reading indicates dryer soil; a lower soil moisture reading means wetter soil. Soil Moisture requires an optional Leaf & Soil Moisture/Temperature Station or Soil Moisture Station and is only available for Wireless Vantage Pro2 Stations.

Time

The Console has a built-in clock and calendar for time and date. When connected to Wi-Fi, the user sets the location and the Console then automatically sets the current time/date, and time zone, as well as determining whether Daylight Saving Time is in use.

APPENDIX B: SPECIFICATIONS

Console Operating Temperature	+32° to +122° F (0° to +50° C)
Non-Operating (Storage) Temperature	-20° to +60° C (-4° to +60° C)
Console Current Draw	2A max
Power Adapter	5 VDC, 2000 mA
Battery Backup	Lithium Polymer
Battery Life (no AC power)	Less than one day when fully charged
Console Display Type	In-Plane Switching LED
Dimensions	
Console	8.25" x 6" x 0.75" (210mm x 152mm x 19mm)
Display Area	6.75" X 4.25" (171mm x 107mm)
Weight	1.1 pounds (501 grams)

Wireless Communication Specifications and Receive Frequencies:

USA	902 - 928 MHz FHSS
EU	868.0 - 868.6 MHz FHSS
Australia, Brazil	918 - 926 MHz FHSS
New Zealand, Peru	921 - 928 MHz FHSS
India	865 - 867 MHz FHSS
Japan	928.15 - 929.65 MHz FHSS
Taiwan, Pakistan	920 - 925 MHz FHSS

ID codes available	8
Range	
Line of Sight	up to 1000 feet (300 m)
Through Walls	200 to 400 feet (75 to 120 m)

APPENDIX C: UPDATE INTERVALS AND WEATHER DATA SPECIFICATIONS

Update Intervals by Sensor

Barometer	Barometric Pressure	1 minute
	Inside Humidity	1 minute
Humidity	Outside Humidity	50 seconds
	Dew Point	10 seconds
Rain	Rainfall Amount	20 seconds
	Rain Storm Amount	20 seconds
	Rain Rate	20 seconds
Temperature	Inside Temperature	1 minute
	Outside Temperature	10 seconds
	Heat Index	10 seconds
Wind	Wind Chill	10 Seconds
	Wind Speed	2.5 seconds
	Wind Direction	2.5 seconds
	Direction of High Speed	2.5 seconds
ET	Evapotranspiration	1 hour

Specifications by Sensor

The following specifications may include parameters that require optional sensors that may not be installed on your sensor suite.

Variable	Resolution	Range	Nominal Accuracy
Barometric Pressure**	0.01" Hg; 0.1 mm Hg; 0.1 hPa; 0.1 mb	16" to 32.5" Hg; 410 to 820 mm Hg; 540 to 1100 hPa; 540 to 1100 mb	0.03" Hg; 0.8 mm Hg 1.0 hPa; 1.0 m
Barometric Trend (3 hour)	Change Rates Rapidly: ≥.06" Hg; 1.5 mm Hg; 2 hPa; 2 mb Slowly: ≥.02" Hg; 0.5 mm Hg; 0.7 hPa; 0.7 mb	5 Arrow Positions: Rising Rapidly Rising Slowly Steady Falling Slowly Falling Rapidly	
Evapotranspiration (ET)*	0.01"; 0.1 mm	199.99"; 1999.9mm	Greater of 5% or 0.01"; 0.25 mm
Inside Temperature	0.1°F; 0.1°C	+32° to +140°F; 0 to +60°C	0.4°F; 0.2°C
Outside Temperature*	0.1°F; 0.1°C	-40° to +150°F; -40° to +65°C	0.5° F, 0.3°C Pro 1°F; 0.5°C VUE
Extra Temperature	0.1°F; 0.1°C	-40° to +150°F; -40° to +65°C	1°F; 0.5°C
Inside Humidity	1%	1 to 100%	2% RH
Outside Humidity	1%	1 to 100%	2% RH
Extra Humidity	1%	1 to 100%	2% RH
Dew Point	1°F; 1°C	105° to +130°F; -76° to +54°C	2°F; 1°C
Heat Index	1°F; 1°C	-40°to +165°F; -40° to +74° C	2°F; 1°C
Daily & Storm Rainfall	0.01"; 0.2 mm	to 99.99", 999.8 mm	Greater of 3% or 1 tip
Monthly & Yearly Rainfall	0.01"; 0.2 mm (1mm at totals over 2000 mm)	to 199.99"; 6553 mm	Greater of 4% or 1 tip
Rain Rate	0.01"; 0.1 mm	to 40"/hr.; 1016 mm/hr.	5% when rate is under 5"/hr.; 127 mm/hr.
Evapotranspiration (ET) <i>Requires Solar Radiation Sensor</i>	0.01"; 0.1 mm	199.99"; 1999.9 mm	greater of 5% or 0.01"; 0.25 mm
Solar Radiation <i>Requires Solar Radiation Sensor</i>	1 W/m2	0 to 1800 W/m2	5% of full scale
UV Index <i>Requires UV Sensor</i>	0.1 Index	0.0 to 16.0	5% of full scale
Wind Direction	1°	1 to 360°	3°
Compass Rose	22.5°	16 compass pts.	
Wind Speed	1 mph; 1 kt; 0.5 m/s; 1 km/h	0 to 200 mph; 0 to 173 kts 3 to 322 km/h, 0 to 89 m/s	Greater of 2 mph/kts; 1 m/s; 3 km/h or 5%
Wind Chill	1°F; 1°C	-110° to +135°F -79° to +57°C	2°F; 1°C
Leaf Wetness <i>(on Leaf & Soil Stn.)</i>	1	0 to 15	0.5
Leaf Wetness <i>(on Leaf & Soil Stn.)</i>	1 cb	0 to 200 cb	

* Outside temperature accuracy is based on the temperature sensor itself and not on the sensor and the passive shielding together. The solar radiation induced error for the radiation shield: +4°F (2°C) at solar noon with the wind speed at less than or equal to 2 mph (1 m/s); The higher the wind speed, the less solar radiation induced error.

**Barometric pressure readings are standardized to sea level. Elevation Range: -1410' to +15,000'; -600 to +4660 m.

APPENDIX D: WIRELESS REPEATER CONFIGURATION

A Vantage Pro2 Wireless Repeater (#7627) or Long-Range Wireless Repeater (#7654) increase transmission distances or improve transmission quality between a station and the Console. A repeater receives information transmitted from a transmitting station and retransmits it to the Console. Depending on transmission distance, one repeater or several repeaters can be used to collect and retransmit weather data. Console communicating with repeaters must be set up with the correct Transmitter ID and Repeater ID before the Console can correctly receive station information.

1. On the Account tab, tap Console Configuration, then tap the pencil icon on Stations and Sensors.
2. Scroll down to the sensor you want to retransmit and tap Edit, then tap Advanced Settings.
3. In the Repeater field, tap > and choose the repeater name that you want console to listen to. If you have more than one this is the one that is closest to the Console. Tap Save Changes.
4. To verify that you have successfully set up your console to receive the repeater, wait 15 minutes to see data appear.

FCC Part 15 Class B Registration Warning

This equipment has been tested and found to comply with the limits for a Class B digital device, pursuant to Part 15 of the FCC Rules. These limits are designed to provide reasonable protection against harmful interference in a residential installation. This equipment radiates radio frequency energy and, if not installed and used in accordance with the instructions, may cause harmful interference to radio communications.

However, there is no guarantee that interference will not occur in a particular installation.

This device complies with part 15 of the FCC Rules. Operation is subject to the following two conditions: (1) this device may not cause harmful interference, and (2) this device must accept any interference, including interference received, including inference that may cause undesired operation.

If this equipment does cause harmful interference to radio or television reception, which can be determined by turning the equipment on and off, the user is encouraged to try to correct the interference by one or more of the following measures:

- Reorient or relocate the receiving antenna.
- Increase the separation between the equipment and receiver.
- Connect the equipment into an outlet on a circuit different from that to which the receiver is connected.
- Consult the dealer or an experienced radio/TV technician for help.

This device complies with Industry Canada license-exempt RSS standard(s). Operation is subject to the following two conditions: (1) this device may not cause interference, and (2) this device must accept any interference, including interference that may cause undesired operation of the device.

Le présent appareil est conforme aux CNR d'Industrie Canada applicables aux appareils radio exempts de licence. L'exploitation est autorisée aux deux conditions suivantes: (1) l'appareil ne doit pas produire de brouillage, et (2) l'appareil doit accepter tout brouillage radioélectrique subi, même si le brouillage est susceptible d'en compromettre le fonctionnement.

Innovation, Science and Economic Development Canada ICES-003 Compliance Label: CAN ICES-3 (B)/NMB-3(B)

Changes or modification not expressly approved in writing by Davis Instruments may void the warranty and void the user’s authority to operate this equipment.

FCC ID: IR2DWW6313U, IC: 3788A-6313U

Information Regarding Exposure to Radio Frequency Energy: The antenna used for this transmitter must be installed to provide a separation distance of at least 20 cm from all persons and must not be co-located or operating in conjunction with any other antenna or transmitter.

Davis Instruments, 3465 Diablo Ave., Hayward, CA 94545

Power Supply Model identifier: FX18B-050200J1 or FX18E-040100J1

Input voltage:	100-240 VAC	Input AC frequency:	50/60 Hz
Output voltage:	5.0 VDC	Output current:	2.0 A
Output power:	10.0 W	Average active efficiency:	78.7%
Efficiency at low load (10 %):	N/A %	No-load power consumption	<0.1 W

 EC-Declaration of Conformity

Directive 2014/53/EU (RED) and 2014/30/EU (EMC)

Manufacturer/responsible person: Davis Instruments

Compliance Engineer

3465 Diablo Ave., Hayward, CA 94545 USA

Declares that the WeatherLink Console models 6313EU, 6313UK, and 6313USB are in compliance with Directive 2014/53/EU. The full text of the EU Declaration of Conformity is available at <https://www.davisinstruments.com/legal>. RoHS Compliant.

WeatherLink Console User Guide

Document number: 7395.402 Rev. C 05/24/2023

For WeatherLink Consoles #6313, 6313EU, 6313UK, 6313USB

Vantage Pro, Vantage Vue, and WeatherLink are registered trademarks of Davis Instruments Corp., Hayward, CA. Davis Instruments, 2022. All rights reserved.

Information in this document is subject to change without notice. Davis Instruments Quality Management is ISO 9001 certified.