

All sitting heights measured without load - a variation may occur depending on the load due to contraction of gas-struts, springs, upholstery and third part equipment. All information herein contained is subject to change without notice unless under contractual configuration control. Please consult NorSap if dimensions are critical or a certified drawing is required.

www.norsap.no

Chair interface: M6 THRU ALL

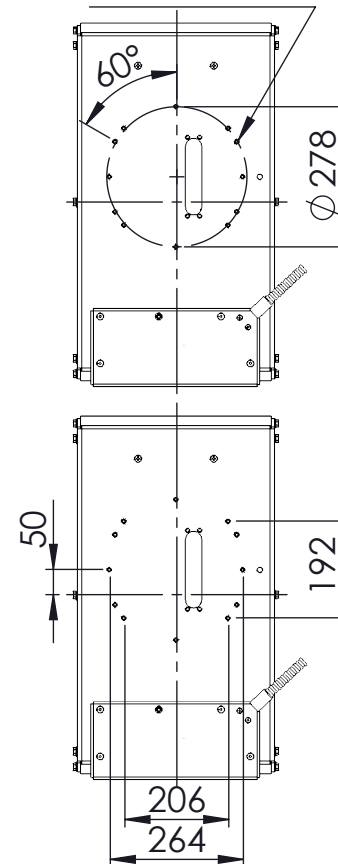

Weight: 0.00



Mjävannsvegen 45/47
NO 4626 Kristiansand (Norway)

Description:
BASIC DECK RAIL TOP MOUNTED, NARROW

Art.-No.: 6250-2500	Date: 04.02.2020	Revision:
------------------------	---------------------	-----------