

All sitting heights measured without load - a variation may occur depending on the load due to contraction of gas-struts, springs, upholstery and third part equipment. All information herein contained is subject to change without notice unless under contractual configuration control. Please consult NorSap if dimensions are critical or a certified drawing is required.

www.norsap.no

Chair interface:

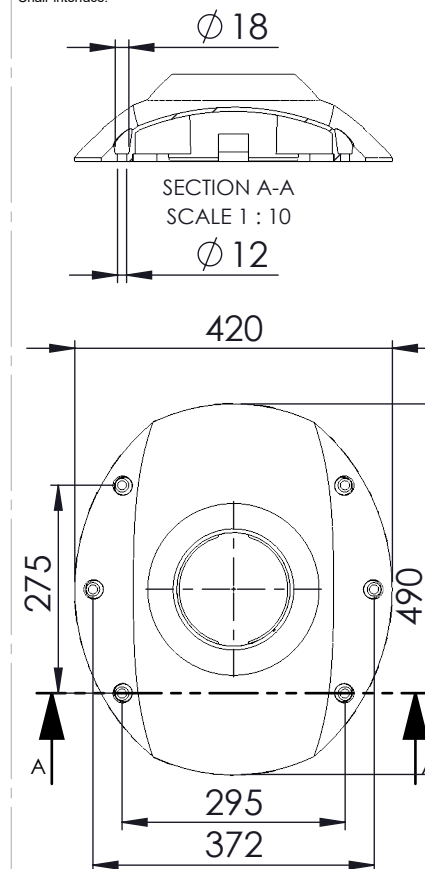

Weight: 99.03



Mjåvannsvegen 45/47  
NO 4626 Kristiansand (Norway)

Description:

Norsap 1600 Standard S

Art.-No.:  
8500

Date:  
10.12.2019

Revision:  
A 1